

# Series 2003 ID PARTS

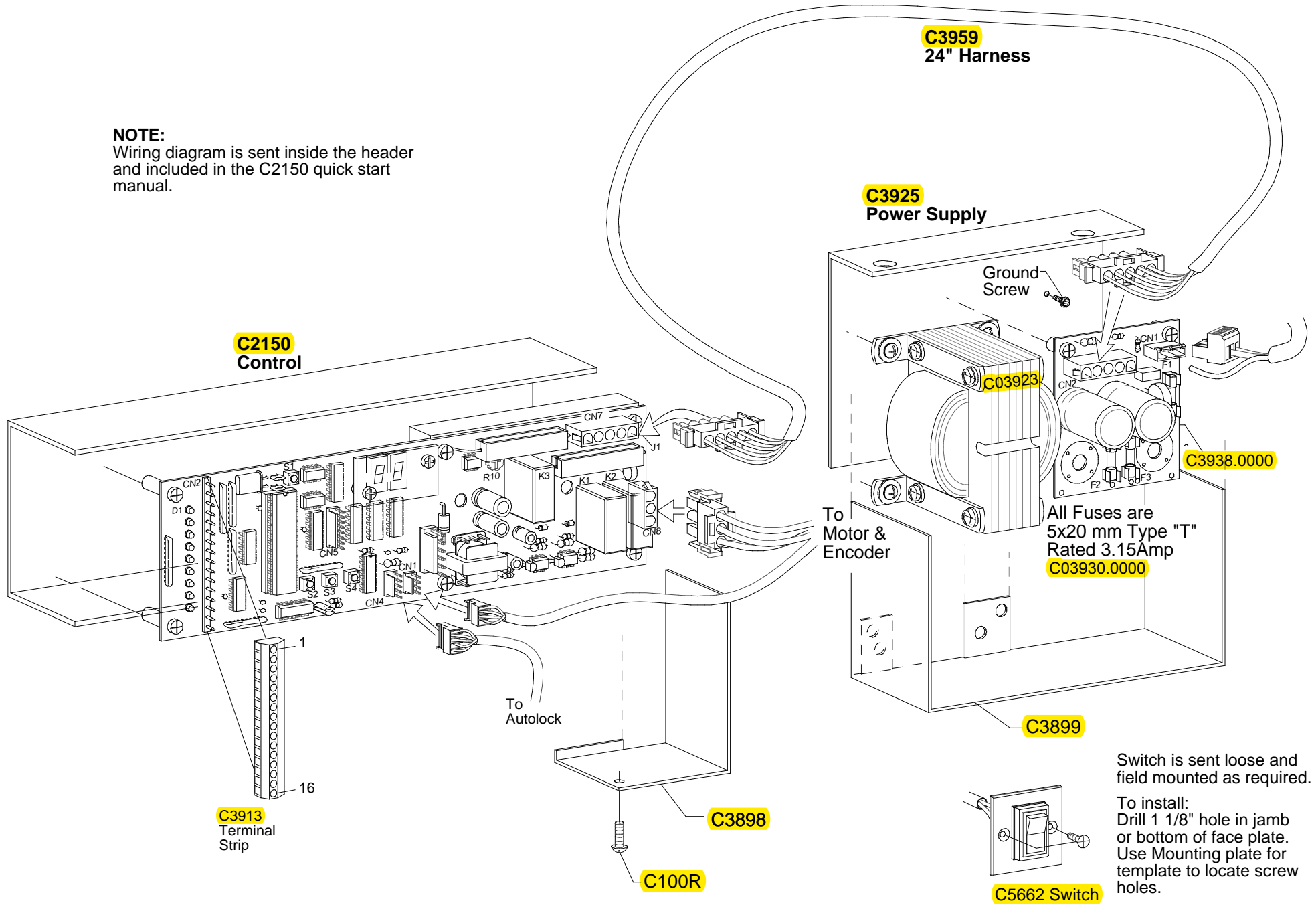

**NOTE:**  
Wiring diagram is sent inside the header  
and included in the C2150 quick start  
manual.



## 15. C2150 MICROPROCESSOR CONTROL

Notas.- Aplicable en la mayoría de las partes aquí ilustradas:

Foto individual – Predomina la parte, ensamble,

(Como referente de opción visto en dibujo o asociación y/o en foto ya aplicada la pieza)

Renglón Descripción en Ingles indicado en PL // Ubicación – uso

Formato es con Número de Parte (en ascendente) no por alfabeto

Venta .-Se sujeta con Precio de Lista MSRP en Dolares

BOLT 4-40X1/2 BHMS PS

Part Number: C00070.0000



BOLT

Part Number: C00100.000R



NUT 1/4-20 KEPS PL

Part Number: C00404.0000



BOLT 10-24X1/2 FH 82 UC PHIL

Part Number: C00437.000A\*



BOLT 10-24X1/2 FH 82 UC PHIL

Part Number: C00437.000B



LOCKWASHER 3/8  
Part Number: C00554.0000



BOLT 1/4-20X1 SCS  
Part Number: C00690.0000

BOLT FOR CLAMP TRACK  
Part Number: C00565.0000

SCREW;SET5/16-18X2,SSS CUP BLK  
Part Number:C01004.0000

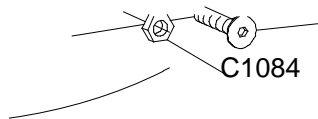

NUT  
Part Number: C01084.0000



Decal " USE COPPER  
Part Number: C01618.0000



Decal UL 2003  
Part Number: C01646.0002

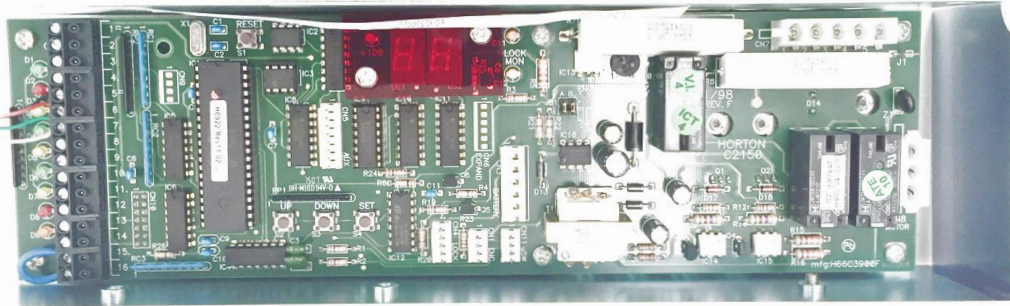

PROC CNTRL VER.11 SW W/SHIELD

**Part Number:** C02150.0011

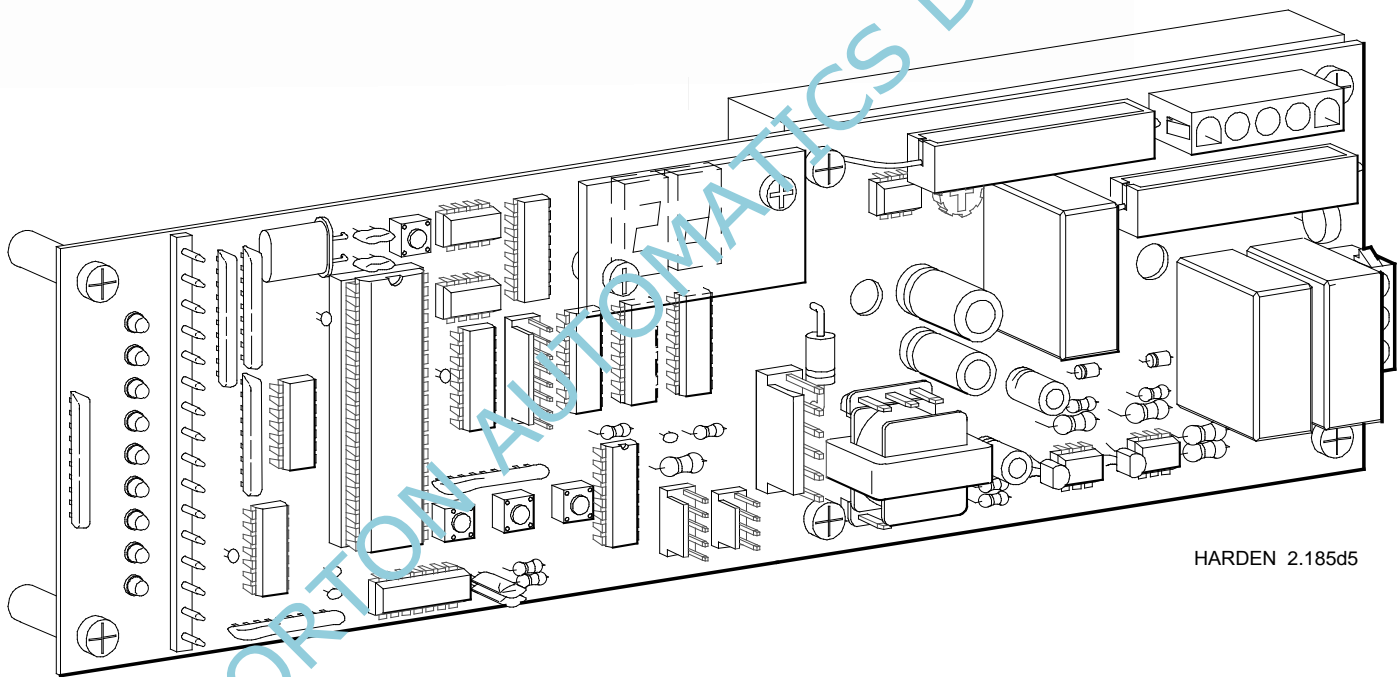



BUSHING 5/16 ID X 3/8 OD X 3/8  
Part Number: 03599.0000



WHEEL CARRIAGE BELT DRIVE  
Part Number: 03632.0005



SHAFT/ANTIRISE ROLLER ASSY  
Part Number: 03633.0002



SPACER-ROLLER-2001  
Part Number: C03634.0000

HORTON AUTOMATICS DE MEXICO



ROLLER TIRE ASSY

**Part Number:** C03636.0000

BOLT

Part Number: C03660

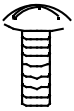

BOLT FOR BELT CLAMP

Part Number: C03664

HORTON AUTOMATICS DE MEXICO





**ASSY-IDLER WHEEL & CARRIAGE**

**Part Number: C03681.0001**

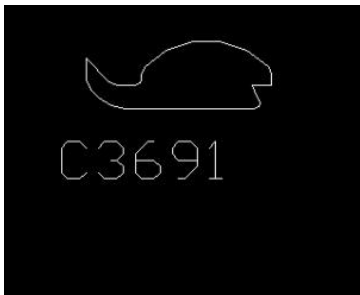

**TOP ALUM TRACK CLR**

**Part Number: C03691.000A**



**Motor Decal rotation arrow**

**Part Number: C03749**

**KEEPER-AUTOLOK LOCK**

**Part Number: C03789.0000**

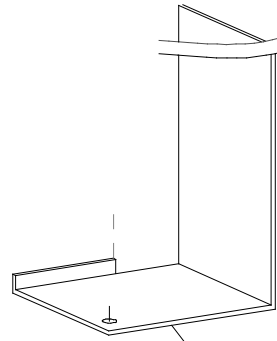

C3898

C2150 SHIELD

Part Number: C03898.0000

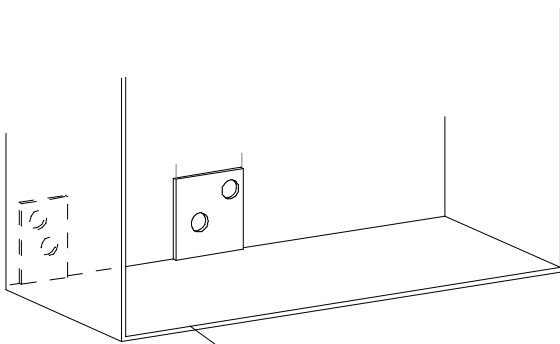

C3899

PWR SUPPLY SHIELD

Part Number: C03899.0000



CONN ALTECH 30.316

Part Number: C03913.0000



TXFMR 120 /90 For C2150  
Part Number: C03923.0000



Fuse 3.15A SLOW BLOW GDC 3.15  
Part Number: C03930.0000

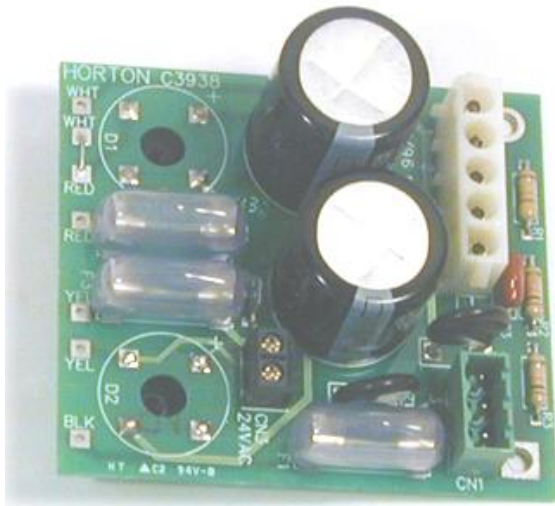

CIRCUIT BOARD PWR SUPPLY ASSY

Part Number: C03938.0000



POWER SUPPLY ( 120V BELT DRIVE )

Part Number: C03925.0000



POWER SUPPLY HARNESS  
Part Number: C03959.0000



TOGGLE SWITCH FOR C2150 ASSY  
Part Number: C03961.0000



CLOSE SWTCH HARNESS

Part Number: C03995.0000



BOLT 5/16-18x5/8 CAP

Part Number: C05054.0000

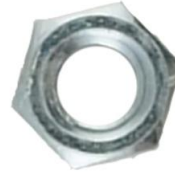

NUT 5/16-18 PLATED

Part Number: C05196.0000



NUT 5/16-18 PL KEP NUT

Part Number: C05196.0001



BOLT 10-32 X 3/8 FH PS PL

Part Number: C05107.0000



WASHER

Part Number: C05293.0000



WASHER 5/16 LOCK

Part Number: C05521.0000

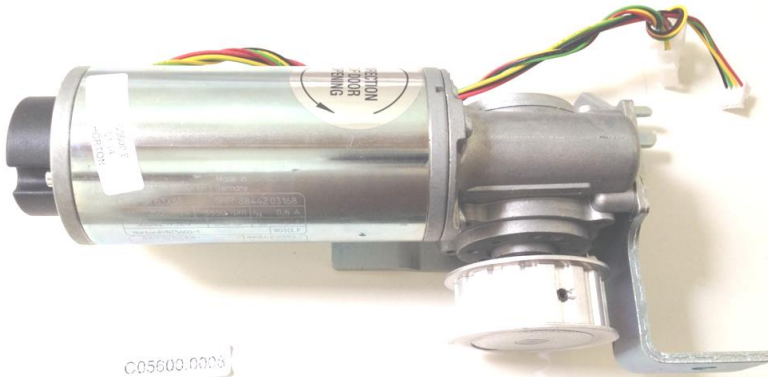

ASSY;MOTOR DUNKER/GEAR DRV MNT-S2003

**Part Number:** C05600.0008



ASSY;MOTOR D MERKLE KOFF /GEAR DRV MNT-S2003

**Part Number:** C05600.0008





BKT-SIDE, GEAR MT TO 2003 HDR  
Part Number: C05605.0008



BKT;TOP-GEAR MT TO 2003 HDR  
Part Number: C05605.0009

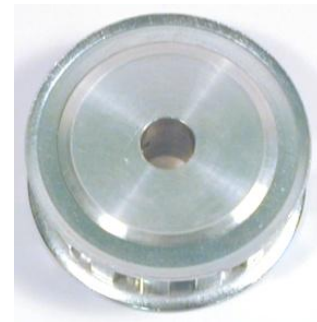

ALUM DRIVE PULLEY (S2003) MECTROL #MP1814  
Part Number: C05621.0000



PIN; SPRING 5/32 X 1-1/2 LG,CS  
Part Number: C05622.0001

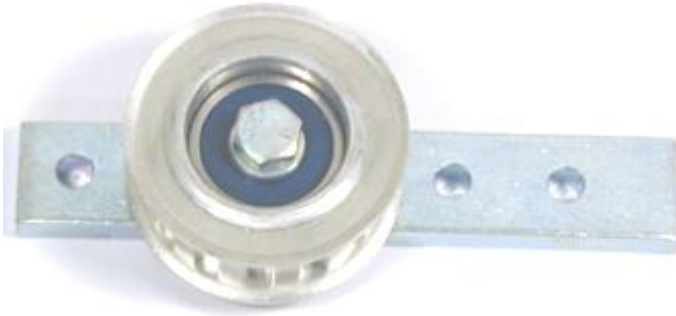

IDLER PULLEY ASSEMBLY Part  
Number: C05623.0000



ALUM IDLER PULLEY (S2003)  
Part Number: C05625.0000



BOLT 5/16-18 X 1 SQ HMB  
Part Number: C05626.0000



BRACKET FOR IDLER PULLEY  
Part Number: C05627.0002



BELT CONNECTOR BKT(STAMPING)  
Part Number: C05629.0000

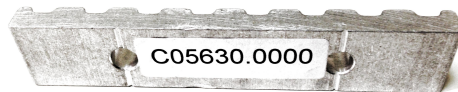

BELT CLAMP  
Part Number: C05630.0000



BRACKET WHEEL CARRIAGE TO BELT  
Part Number: C05631.0000



BUCKLE RUBBER STOP  
Part Number: C05632.0000



SPACER BASE RUBBER STOP  
Part Number: C05633.0000



ANCHOR BOLTS BASE RUBBER STOP  
Part Number: C05634.0000



RUBBER STOP  
Part Number: C05635.0000

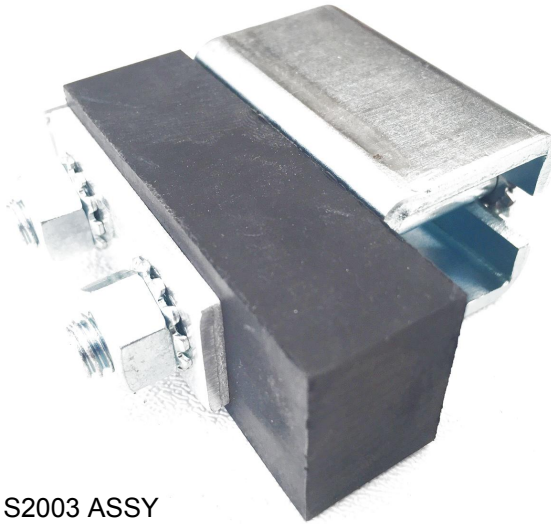

BUMPER S2003 ASSY  
Part Number: C05636.0000

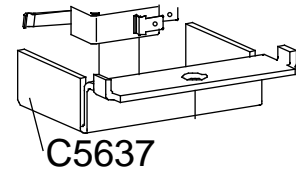

CLOSE MONITOR SWITCH BASE  
Part Number: C05637.0000



CLOSE MONITOR SWITCH  
Part Number: C05638.0000



BELT : COG .50" X .50" W S2003  
Part Number: C05639.0001



BELT : COG .50" X .50" W S2003  
Part Number: C05641.0000



BELT : COG .50" X .50" W S2003  
Part Number: C05642.0000

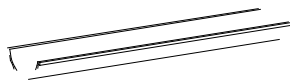

EXTRUSION VINYL WIRE GUIDE  
Part Number: C05644.0000

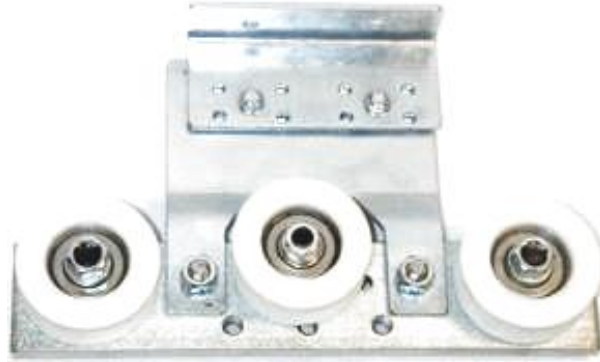

DRIVE WHEEL CARRIAGE 2003 ASSY  
Part Number: C05646.0000



HEADER ENDCAP INFRAME MNT 2003  
Part Number: C05652.000A



HEADER ENDCAP  
Part Number: 05653.000A





TAPPING PLATE HDR TO JAMB 2003

Part Number: C05654.0000

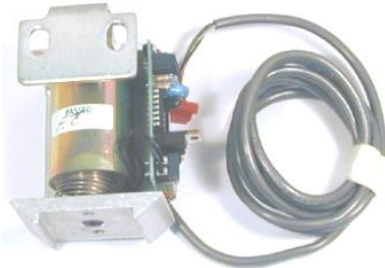

AUTOLOCK 2003 FAIL SEC C2150

Part Number: C05656.0000



AUTOLOCK 2003 FAIL SAFE C2150

Part Number C05657.0000

HORTON AUTOMATICS DE MEXICO



ON/OFF ROCKER SWITCH ASSY

Part Number: C05662.0000

HORTON AUTOMATICS DE MEXICO

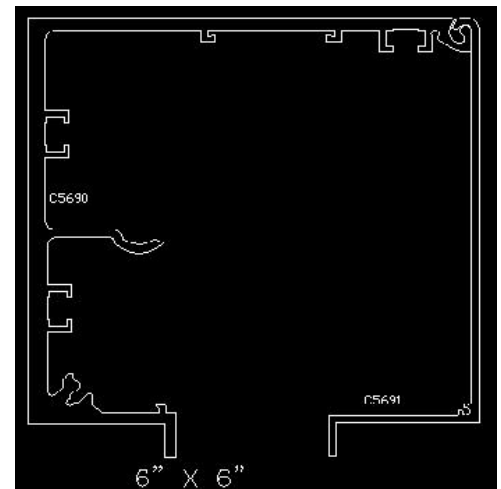

Series 2003 Header

Part Number: C05690.000A



BOLT SQ HEAD 5/16-18 X5/8  
Part Number: C07498.0000

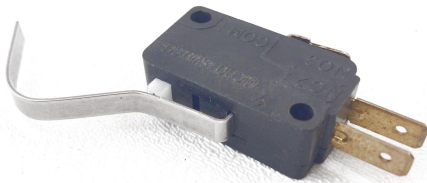

SWITCH WITH BENT ARM  
Part Number: C08258.0000



Screw PH Head  
Part Number: C09029.0000



BOLT 3/8-16 X 1 1/2 FHSCS  
Number: C09651.0000



NUT 3/8-16 HEX  
Part Number: C09655.0000

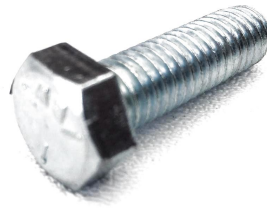

BOLT

Part Number: C09656



ROCKER SWITCH SELECTA RH03  
Part Number c09685.0000



Part Number: C012158



Part Number: C012158 Mx



web 26 03 16

## *Notas.*

---

